



WAREWASHING
RACK-TYPE DISHWASHER

PROFI CN

EFFICIENT - RELIABLE - INNOVATIVE



 made in germany

MADE IN GERMANY

"Made in Germany" has been synonymous with quality and reliability in the premium segment for a long time and still is today. A company can only maintain its hold on the market by keeping its promise to continually deliver high quality.

WORLDWIDE

Whether you need a completely new kitchen or a replacement item our competent subsidiaries and partners all over the world would be pleased to support you. It's nice to know we are always there.



1883 Mr. Charles Clarence Hobart builds his first engines and generators in Middletown, Ohio.

1886 J.C. Cochran receives the patent for the first dishwasher.

1897 The HOBART ELECTRICAL MANUFACTURING COMPANY was founded in Troy Ohio, through the acquisition of the engine and generator factory of the HOBART family.

1903 HOBART builds the first food processor (a self-contained powered coffee mill).

1926 HOBART purchases The Crescent Washing Machine Company, and enters the commercial warewashing market: the first warewashing machine carrying a HOBART label.

1930 Foundation of the HOBART MASCHINEN GESELLSCHAFT in Hamburg, Germany.

1953 HOBART receives the patent for the first flight-type dishwasher.

1960 Acquisition of the dishwashing department of the company K. Martin, Offenburg, Germany.

1980 Production plant in Elgersweier, Germany, was newly built.

1986 PREMARK INTERNATIONAL GROUP was formed in Deerfield, Illinois.

1997 HOBART CORPORATION'S 100th anniversary.

1999 Integration of PREMARK into ITW.

2004 HOBART relocates to Elgersweier

2006 Launch of HOBART's export activities

2007 HOBART's PREMAX line begins a new chapter in the annals of dishwashing technology.

The PREMAX FTP flight-type dishwasher cuts water use by up to 50%, energy use by up to 30%, and use of chemicals by up to 80%.

2009 HOBART introduces the SENSOTRONIC, the world's first intelligent dishwashing technology

2010 Tenth record year in succession for HOBART

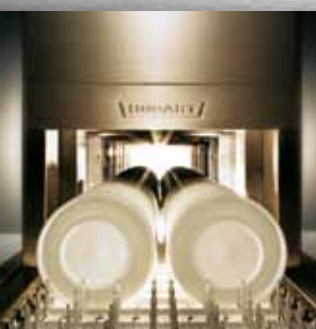



THE COMPANY

Based in Offenburg, Germany, HOBART leads the world market in industrial warewashing technology. We serve customers such as hotels, restaurants and caterer, bakeries and butcheries as well as supermarkets, airlines and cruise ships across the world.

HOBART develops, produces and sells warewash, cooking, food preparation and waste treatment appliances and systems, and employs around 6,865 staff members across the world, 903 of them in Germany. HOBART is a subsidiary of the US Illinois Tool Works (ITW) Group, which manufactures and sells a variety of products; the group has a staff of 65,000 employees in 875 autonomous companies in 49 countries.

OUR VISION

WASH WITHOUT WATER

Our intensive market research has shown unequivocally that our customers require appliances that are economical and ecological while still producing first-class results. We have addressed this demand and worked out our vision, *Wash Without Water*. The resulting areas of focus – innovation, economy, ecology – set the direction. Our vision means leaving no stone unturned when it comes to reducing water, energy and detergent consumption.

UTOPIAN?

Everything begins with a vision. Many of the products that make everyday life easier today began as the ideas of a visionary; many of these ideas would have seemed utopian at the time. There can be no progress without a vision – and that applies to warewashing as much as anything else. Before the introduction of PREMAX, a dishwasher with a 50% water saving technology would have been utopia. Today, PREMAX has set new standards, and we by now know that whenever the dishwasher that washes without water will come, it'll be a PREMAX.



FOCUS

INNOVATION

Innovation means more than just turning an idea into reality. We at HOBART see innovation as a continuous process. In fact, we've put more than 30 innovative products onto the market since the PREMAX launch. All these innovations share one single goal – to generate real value added for our customers.

We have a global network of more than 300 research and development engineers to make this possible, plus marketing teams out on every continent to identify customer preferences and requirements. We have a group technology centre in the US with more than a 1,000 patent applications a year, together with an innovation centre for warewashing in Offenburg, Germany.

ECONOMY

Already in the early 1980s our energy-formula set benchmarks in energy saving and recovery which are still unique today. This innovative spirit found its fulfillment in the PREMAX line. The PREMAX flight-type dishwasher saves up to 50% water, 30% energy, and 80% chemicals in comparison to conventional technologies, making HOBART a pioneer in terms of efficiency and economy.

ECOLOGY

The HOBART environmental protection program CO₂NSEQUENT has been in existence for some time. The program includes a large number of measures that are all related to protecting the environment. These measures are implemented in production, purchasing, the development and sale of products and in additional projects. As an example, you might like to know that all HOBART products are manufactured using regenerative energy only.



1

2

3

4

1 "We operate at constant high capacity. One bus after the other stops at our motorway service area for a break. Our warewashing has to cope and cannot afford to break down. With the PROFi CN, we have found the perfect machine for our needs."

2 "The eye leads to the stomach. Therefore we devote great attention to the presentation of our food. Sparkling and hygienically clean tableware are an obvious prerequisite. With the PROFi CN, we can guarantee this at all times."

3 "In addition to keeping operating costs down, we have stringent demands regarding hygiene. The PROFi CN satisfies both. It gives us the security of reduced operating costs, which pleases the management."

4 "Throughout the day, we get a constant flow of wash ware. Therefore a rack-type dishwasher was the right choice for us. Even though we are strapped for space, the PROFi CN fits in perfectly and is a reliable partner around the clock."

Marjan Ružič
Motorway service area
Ljubljana, Slovenia

Darja Tamm
Restaurant
Tallinn, Estonia

Juan Ogella
Retirement and nursing home
Sevilla, Spain

Dimitry Plostak
Hotel
Moskva, Russia



1 | ECONOMY

PATENT

ENERGY-MANAGEMENT EFFICIENT

A conventional rack-type dishwasher loses 40% of the energy available in the machine via the exhaust system. The distribution of water and the air stream have a considerable influence. The new energy-management EFFICIENT reduces the evaporation loss. The improved arrangement of the wide angle nozzles FAN and the orientation of the wash arms reduce the air flow within the machine. The patent pending wide angle nozzle FAN spreads out a 65% wider and more even spray pattern. Therefore the recirculation of water can be reduced for the same wash result. In order to keep the system in balance less air/water steam has to be exhausted. The new energy-management reduces the energy loss of the rack-type dishwasher by up to 15%.

PATENT

DETERGENT SAVING SYSTEM LOW-CHEM

With the optional detergent saving system LOW-CHEM detergent is injected directly into the wash tank, which is continuously regenerated by fresh water from the rinse. Therefore detergent is added to maintain the concentration according to the added regeneration volume. The enhanced LOW-CHEM detergent saving system directs only 105 litres of fresh rinse water into the wash tank for regeneration. Ahead of the final rinse, detergent is flushed off the wash ware by the RADIUS pre-rinse nozzle and diverted back into the wash tank. The dosing of detergent depends on the regeneration water volume. As a result detergent consumption is reduced by up to 70% compared to conventional systems.

EFFICIENT – OPTIMAL



Up to 65% wider and more even spray pattern.

ECOLOGICAL – ECONOMICAL

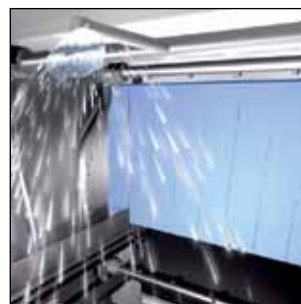

Up to 70% detergent saving.

HOBART

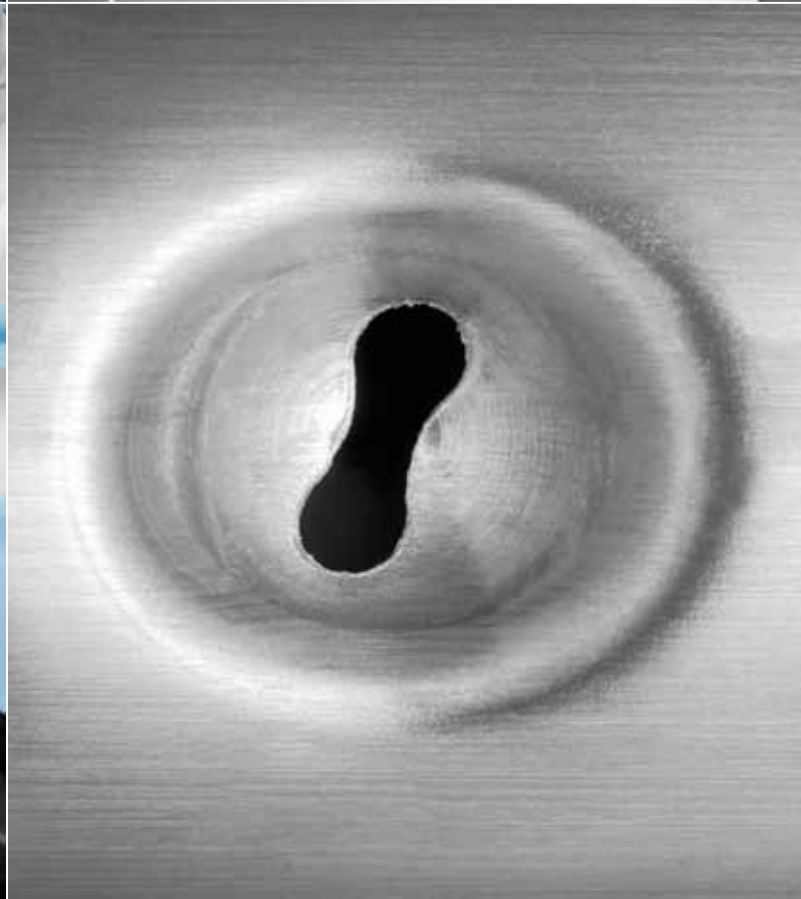

1 | ECONOMY

HOBART HEAT RECOVERY

HOBART's heat recovery system functions according to the countercurrent principle, using the energy from the extracted air to heat up the incoming water. The energy exchange takes place in the HOBART high-performance condenser. At the same time, the extracted air is cooled down and dehumidified. The HOBART heat recovery system reduces energy consumption by up to 8.5 kW and total connected load to 36.7 kW.¹⁾ The extracted air can be led directly into the building's ventilation ducting.²⁾

HOBART HEAT PUMP

THE HOBART heat pump uses the residual energy in the extracted air following heat recovery. A compressor and refrigerant are used to ensure efficient heat recovery. The amount of recovered energy is sufficient to heat the wash and rinse water. This innovative technology reduces energy consumption by up to 10 kWh and total connected load to 29.9 kW.³⁾ The temperature of the extracted air is reduced to approx. 20-24°C.⁴⁾ The extracted air can be blown directly into the room.²⁾

¹⁾ Calculation example for the PROFI CN S-A-DS, C20 compared to models without heat recovery

²⁾ Conditional on compliance with VDI 2052

³⁾ Calculation example for the PROFI CN S-A-DS, CHP compared to models without heat pump

2 | WASH RESULT

PATENT

WASH SYSTEM CONTACT-PLUS

The impact with detergent solution via the wash arms is, apart from the temperature, the main factor influencing the cleaning result. The precision of the FAN wide angle nozzles makes it possible to reduce the distances between the wash arms. The wash arms are located very close to one another and thus achieving full cleaning performance. In connection with the 65% wider wash jets the new configuration of the FAN wide angle nozzles washes the items three times per wash arm. The new wash system CONTACT-PLUS with its 6 wash arms above and 5 wash arms below guarantees an optimal wash result.

⁴⁾ Values in continuous operation +/-10 % depending on incoming air in the room and inlet temperature of the fresh water (values based on 10°C incoming water and 23°C ambient air temperature)

ECONOMICAL – EFFICIENT



The HOBART heat pump uses the residual energy in the extracted air.

PERFORMANCE – POWERFUL



Highest performance due to 6 wash arms above and 5 wash arms below.

HOBART



2 | WASH RESULT

PATENT

RINSE TRI

The optional HOBART triple rinse TRI consists of the RADIUS pre-rinse nozzle, a pumped rinse and a fresh water final rinse. The RADIUS pre-rinse nozzle rinses off most detergent from the wash ware before entering the rinse zone. The water is directed back into the wash tank, minimizing detergent addition into the recirculating rinse water.

3 | HANDLING

HANDLING ASSISTANT EASY

featuring

- SMARTRONIC control
- PROTRONIC control
- Drop-In wash system
- Coded wash and rinse arms
- Coded curtains

SMARTRONIC CONTROL

Switch on/off – all other functions are automatically assumed by the control.

PROTRONIC CONTROL

The innovative, multi-line text and symbol display is operated by touchscreen. This ensures easy operation and minimises errors.

DROP-IN WASH SYSTEM

Easy to take out and insert.

CODED WASH AND RINSE ARMS

The wash and rinse arms are clearly designed to prevent risk of confusion when inserting.

CODED CURTAINS

Easy to take out and insert. The clear marking on the wash curtains prevents confusion when inserting.

DIRECT – DYNAMIC



Best wash results due to triple rinse.

OBVIOUS – SIMPLE



The curtains are marked distinctively.

HOBART

4 | SUPPORT

CLEANING ASSISTANT SUPPORT

comprising

- Wash system
- Bayonet catch
- Completely moulded washing tanks
- 1-part strainer
- 150 mm floor clearance
- Condenser
- Panorama door

WASH SYSTEM

The wash systems are easy to remove and to insert due to a drawer mechanism.

BAYONET WASH ARM CATCH

The wash arms can easily be opened and closed to simplify cleaning.

MOULDED DRAIN ELEMENT

Dirt is directed via beading to a central point and into the drain. This prevents dirt accumulation in the tank.

COMPLETELY MOULDED TANK

The tank sump and tank bottom are moulded from one single part. There are no corners and edges or weld seams where dirt could accumulate. This optimizes cleaning and hygiene.

CONDENSER

Optimal accessibility for water spraying - by simply removing the front covering.

SIMPLE – CLEAN



Wash arms can easily be opened and closed.



5 | TECHNICAL DATA

Racks (number/h)			Conveyor speed (m/min)	Water consumption		Energy consumption (connected load) [kWh; (kW)]		Recommended model selection	Total length (in mm without drying zone)
Speed 1	Speed 2 (as per DIN 10510)	Speed 3		(l/h)	(l/rack)	with heat recovery	with heat pump		
-	90	120	0.67	230	1.9	28.0 (31.5)	20.0 (24.7)	CNA	1,350
-	100	150	0.83	240	1.6	28.0 (31.8)	19.0 (24.9)	CNE-A	1,850
-	120	180	1.00	260	1.4	32.0 (36.0)	22.0 (29.2)	CN-L-A	2,000
-	120	180	1.00	260	1.4	32.0 (36.0)	22.0 (29.2)	CN-C-A	2,375
-	150	220	1.25	260	1.2	33.5 (36.7)	23.5 (29.9)	CN-S-A	2,250
120	180	250	1.50	260	1.0	33.5 (38.5)	24.0 (31.6)	CNE-SA	2,750
120	180	260	1.50	330	1.27	43.0 (48.7)	33.5 (40.9)	CN-L-AA	2,950
120	190	280	1.58	330	1.2	44.5 (49.4)	35.0 (41.6)	CN-S-AA	3,150
120	210	320	1.75	330	1.03	44.5 (49.4)	35.0 (41.6)	CNE-S-AA	3,650

6 | MODULE SELECTION

PRE-WASH ZONE

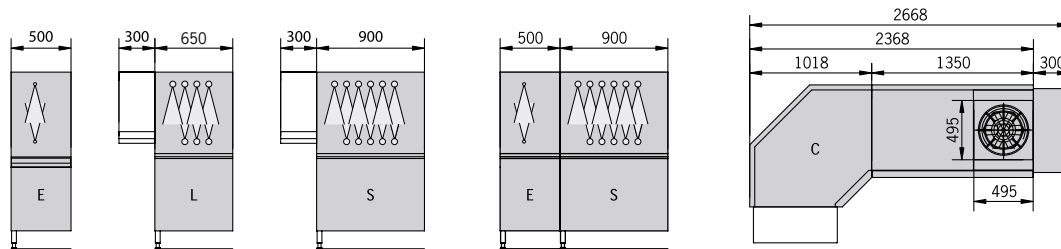

MAIN WASH ZONE

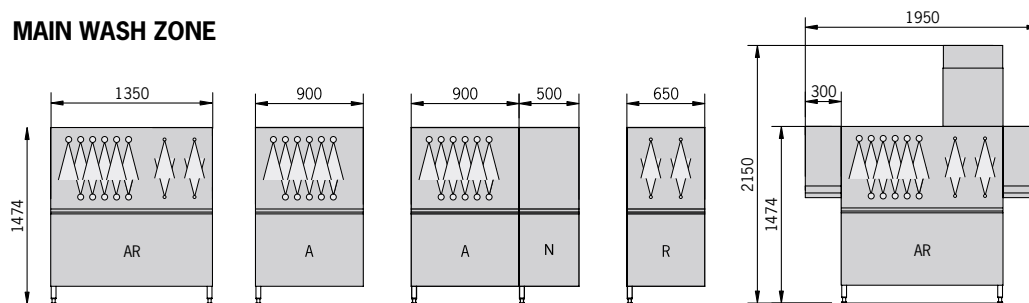

DRYING ZONE

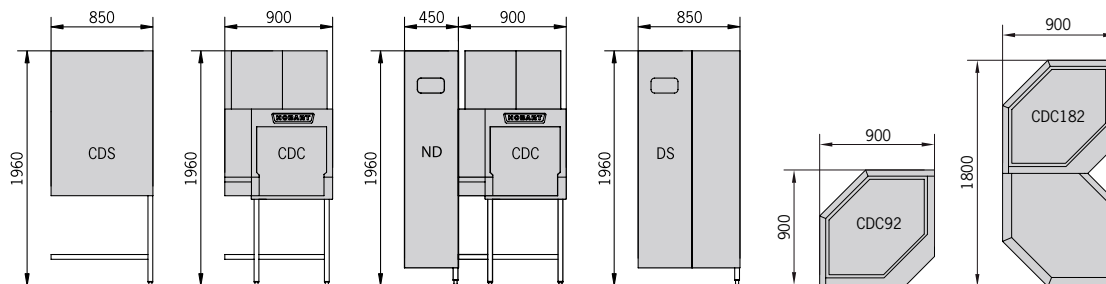

HEAT RECOVERY/HEAT PUMP

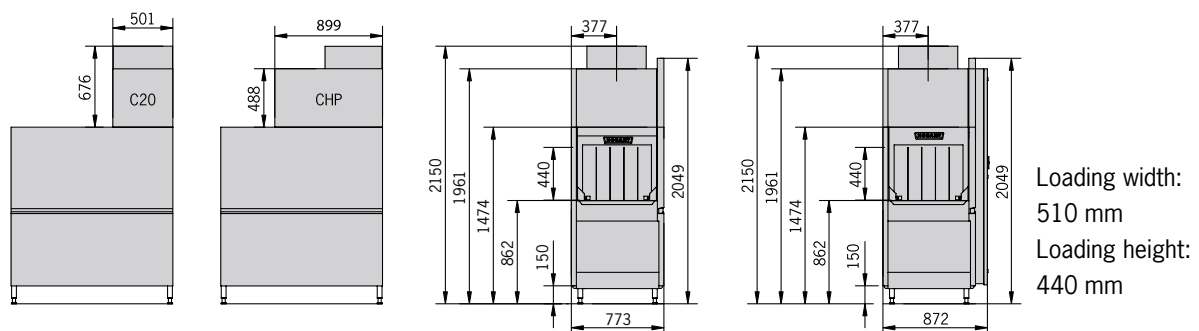

WAREWASHING
RACK-TYPE DISHWASHER

PROFI CN

EFFICIENT – RELIABLE – INNOVATIVE

GOOD – BETTER – PROFI

Under continuous high capacity conditions in hotels, restaurants, nursing homes, canteens and motorway service areas, warewashing equipment must meet the most stringent requirements in terms of quality and reliability.

With its energy management system EFFICIENT and its highly effective heat recovery systems, HOBART sets new economical standards in rack-type dishwashers, while also protecting the environment by reducing consumption levels.

With its perfectly hygienic wash result and practical use features, the PROFI CN stands for quality – made by HOBART.



WAREWASHING

COOKING

FOOD PREPARATION

WASTE TREATMENT

SERVICE

HOBART GMBH

Robert-Bosch-Straße 17

77656 Offenburg/GERMANY

Phone +49(0)781.600-28 20

Fax +49(0)781.600-28 19

email: info-export@hobart.de

www.hobart-export.com

EFFICIENT – RELIABLE – INNOVATIVE

Member of the *ITW* Food Equipment Group Europe

